



Eshmuno® CP-FT Resin

A cation exchange resin specifically developed for the flow-through removal of aggregates using frontal chromatography

Aggregates in monoclonal antibody (mAb) therapeutics pose a significant risk to patients by increasing the potential of an immunogenic response and reducing efficacy. In contrast to other mAb impurities, aggregates are not efficiently removed by protein A chromatography. They are particularly challenging to separate from the monomeric protein since they have very similar isoelectric points and hydrophobicities.

Eshmuno® CP-FT cation exchange (CEX) resin is specifically designed to provide efficient removal of mAb aggregates in the flow-through frontal chromatography mode of operation enabling loading capacities 10× higher than traditional bind/elute CEX chromatography. Eshmuno® CP-FT resin facilitates greater manufacturing flexibility and process intensification while reducing the overall cost for the downstream purification of mAbs.

Benefits

Increased performance

- Superior flow-through removal of mAb aggregates
- High product recoveries at high mass loadings

Reduced costs

- Significant reduction in resin and buffer volume
- Smaller manufacturing footprint (smaller columns, buffer tanks, etc.)

Intensified process

- Low salt process conditions eliminate the need for dilution before subsequent ion exchange steps
- Significant reduction in processing volumes improves virus filtration and ultrafiltration processing economics

Enhanced ease of use

- Rigid base bead enables higher flow rates and easier column packing



Enabling Flow-Through Efficiency

Eshmuno® CP-FT resin was developed for the efficient flow-through removal of aggregates under strong binding conditions (pH 4.0-5.5, 3-7 mS/cm) that favor frontal chromatography. Under these conditions, both the mAb monomer product and the mAb aggregates will initially bind to the Eshmuno® CP-FT resin. The resin has a novel CEX tentacle surface chemistry (Figure 1) that facilitates displacement of the bound monomer by the larger aggregates enabling efficient removal of aggregates using a frontal chromatography mechanism.

The example in Figure 2 demonstrates the efficient removal of aggregates from mAb feed containing a challenging level of aggregates (7%). The monomer breaks through the column much earlier than the aggregates. Thus, the monomer recovery exceeds 85% at 600 g/L while the percentage of aggregates in the flow-through pool does not reach 1% until after a loading of 1000 g/L.

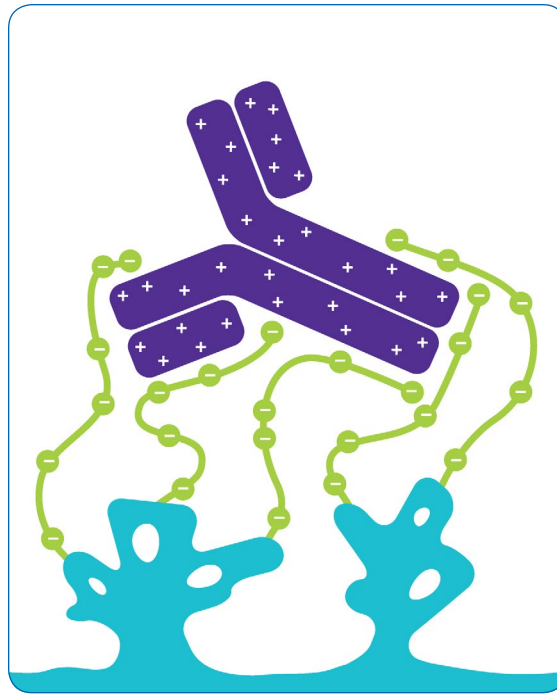

Figure 1.

Resin tentacles form a multipoint three-dimensional ion exchange network that enables easy access of the proteins to the ligands providing fast mass transport.

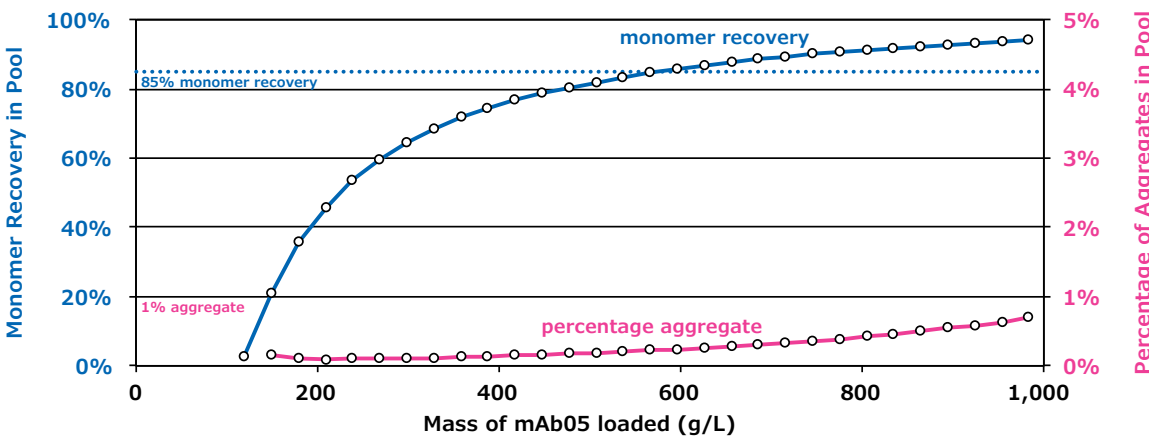

Figure 2.

Cumulative recovery of mAb05 monomer as a function of the mass of mAb05 loaded onto the column (blue—). Cumulative percentage of aggregates as a function of the mass of mAb05 loaded onto the column (pink—).

Using Eshmuno® CP-FT resin for high loading flow-through CEX chromatography offers significant savings over conventional CEX bind/elute chromatography processes. For instance, purifying 1 kg of a mAb using Eshmuno® CP-FT resin at a loading of 1,000 g/L would only require 1 L of resin and 15 L of buffer (Figure 3). This is significantly less than a CEX bind/elute chromatography process loaded to 80 g/L that would require 12.5 L of resin and 313 L of buffer.

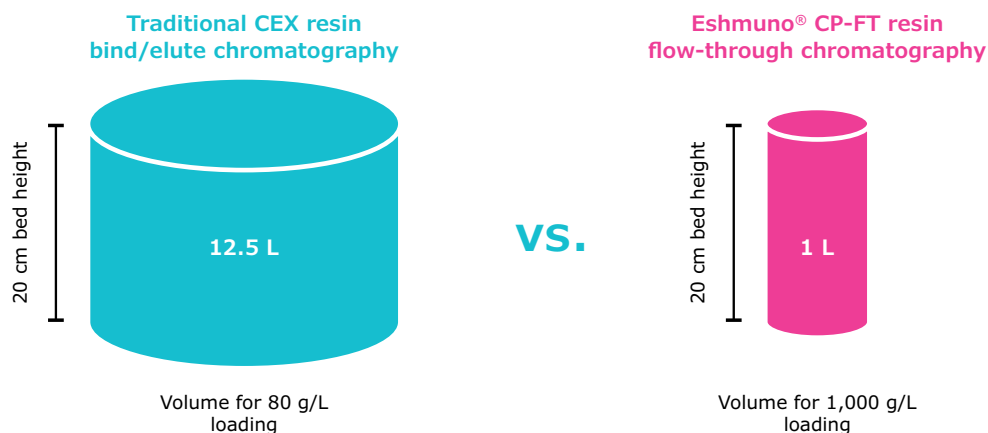

Figure 3.

Volume of columns to purify 1 kg of mAb.

Demonstrated Performance

The removal of aggregates and HCP was examined as part of a three-step downstream purification for two different mAb feed streams (Figure 4). The three-step purification was composed of a protein A affinity chromatography step (Eshmuno® A resin), a CEX chromatography step in the bind/elute mode (Eshmuno® CPX resin) or in the flow-through mode (Eshmuno® CP-FT resin), followed by a strong anion exchange (AEX) resin (Eshmuno® Q resin).

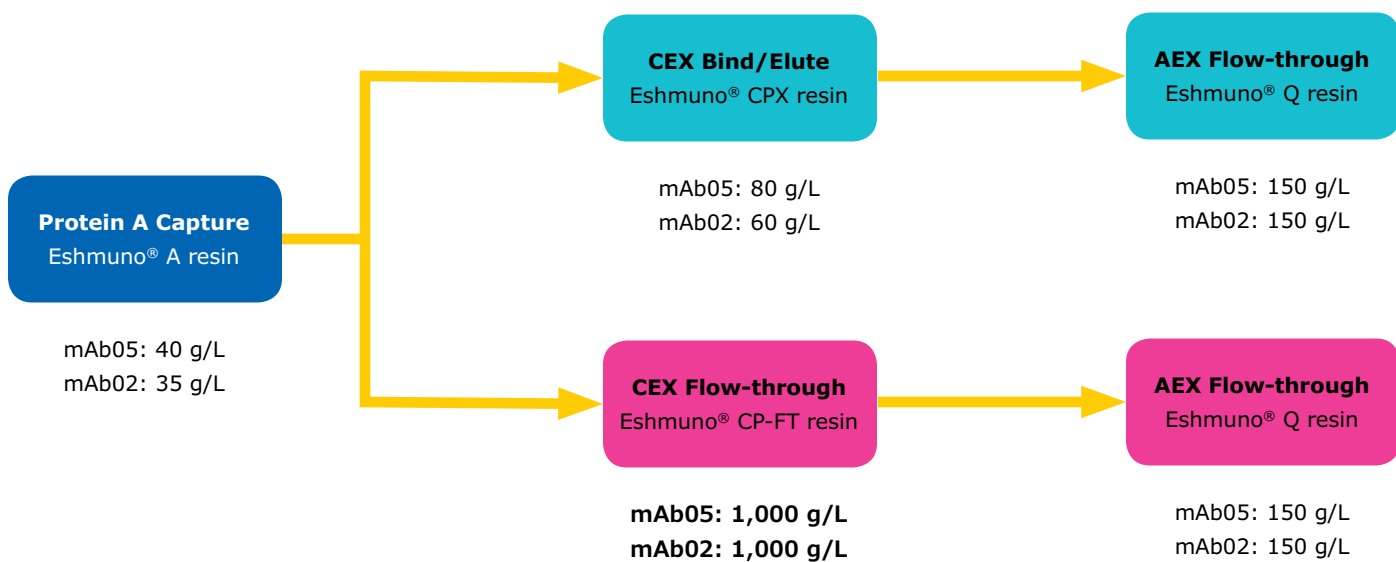

Figure 4.

Flow chart of the 3-step purification of mAb05 and mAb02. The loadings used for each purification step are listed below the respective unit operation.

Table 1.

Comparison of a 3-step process having a CEX bind/elute chromatography step to a 3-step process having a CEX flow-through frontal chromatography step for the purification of mAb05.

Chromatography Step	Loading (g/L)	Monomer recovery	Aggregates in pool	HCP in pool (ppm)	mAb concentration (g/L)
1. Capture: Eshmuno® A resin (adjusted to pH 5.0)	40	88%	3.06%	47	15.1
2. CEX bind/elute: Eshmuno® CPX resin	80	87%	0.42%	3	15.8
3. AEX flow-through: Eshmuno® Q resin	150	>99%	0.43%	1	3.1
2. CEX flow-through: Eshmuno® CP-FT resin	1,000	92%	0.55%	17	13.6
3. AEX flow-through: Eshmuno® Q resin	150	>99%	0.61%	3	8.7

Table 2.

Comparison of a 3-step process having a CEX bind/elute chromatography step to a 3-step process having a CEX flow-through frontal chromatography step for the purification of mAb02.

Chromatography Step	Loading (g/L)	Monomer recovery	Aggregates in pool	HCP in pool (ppm)	mAb concentration (g/L)
1. Capture: Eshmuno® A resin (adjusted to pH 6.0)	35	97%	2.88%	228	14.9
2. CEX bind/elute: Eshmuno® CPX resin	60	98%	1.84%	63	9.9
3. AEX flow-through: Eshmuno® Q resin	150	>99%	1.44%	4	3.1
1. Capture: Eshmuno® A resin (adjusted to pH 4.0)	35	97%	2.43%	302	15.4
2. CEX flow-through: Eshmuno® CP-FT resin	1,000	91%	0.77%	181	13.7
3. AEX flow-through: Eshmuno® Q resin	150	>99%	0.98%	9	8.5

Case study #1 with mAb05 demonstrated that the 3-step process with a CEX flow-through frontal chromatography step loaded to 1,000 g/L removed similar amounts of HCP and aggregates to the 3-step process with a bind/elute CEX chromatography step loaded to 80 g/L. The CEX flow-through step results in a lower conductivity feed eliminating the need for dilution prior to the AEX flow-through step with Eshmuno® Q resin. The higher concentration feed reduces the solution volume needed to be processed through subsequent virus filtration and ultrafiltration steps. As a result, Eshmuno® CP-FT resin requires significantly less resin and buffer and is an ideal choice for the removal of aggregates within an intensified process.

Case study #2 with mAb02 found that using flow-through frontal chromatography with Eshmuno® CP-FT resin was more effective than CEX bind/elute chromatography and was able to reduce the level of mAb aggregates below the target of 1%. Even after optimizing the loading conditions (pH 6.0) and lowering the loading down from 80 g/L to 60 g/L, the level of aggregates could not be reduced below 1% using CEX bind/elute chromatography. The results indicate that flow-through chromatography with Eshmuno® CP-FT resin offers a special selectivity enabling the removal of aggregates from feeds with particularly difficult aggregates.

Flow-Through Virus Removal

Clearance studies with Eshmuno® CP-FT resin were also performed to demonstrate the removal of both xenotropic murine leukemia virus (X-MuLV) and minute virus of mice (MVM) from a mAb05 feed under strong binding conditions in the flow-through mode. At a loading of 1,000 g/L, a cumulative log reduction value (LRV) of 3.4 was demonstrated for X-MuLV and 3.1 for MVM (Figure 5). The results indicate that using Eshmuno® CP-FT resin for the flow-through removal of aggregates also has the potential to positively contribute to the overall virus removal strategy for a downstream purification process.

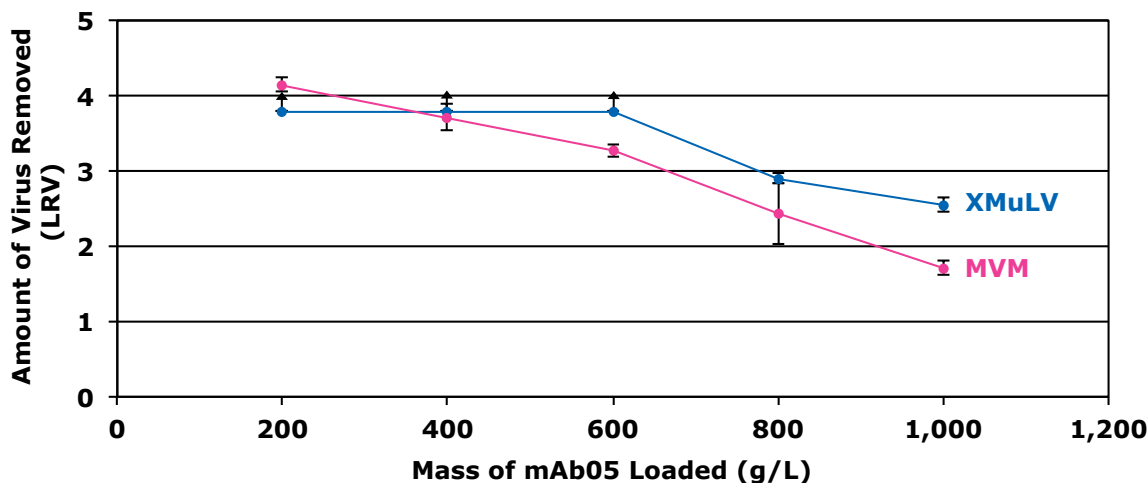

Figure 5.

MAB05 feed with 10% aggregates was dialyzed into a buffer composed of 100 mM acetate at pH 5.0 and 5.0 mS/cm then spiked with virus and processed through a 1.0 mL (0.66 cm i.d., 3.0 cm bed height) column of Eshmuno® CP-FT resin. Virus removal was assessed throughout the run and LRVs are shown at increasing mass loading on Eshmuno® CP-FT resin. Collection points where no virus was detected are indicated with an arrow.

Proven Eshmuno® Technology

Eshmuno® CP-FT resin is a member of our high performance Eshmuno® platform, which is a family of chromatography resins designed to meet the demands of highly productive downstream purification processes. Eshmuno® base beads (Figure 6) are composed of a hydrophilic polyvinyl ether polymer that enables high flow rates resulting in shorter processing times. Eshmuno® CP-FT resin can be easily packed into production-scale columns, either by simple flow packing or axial compression. The pressure-flow curves for 10 and 20 cm i.d. columns at 20 cm bed height are shown in Figure 7 demonstrating linear scalability.

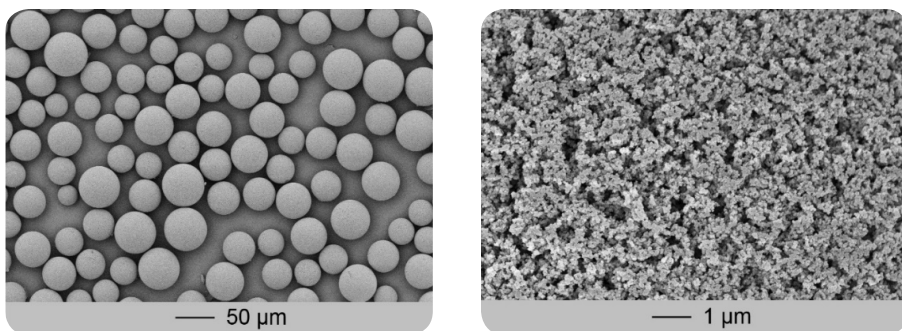

Figure 6.

SEM pictures of 50 µm particle size Eshmuno® CP-FT resin.

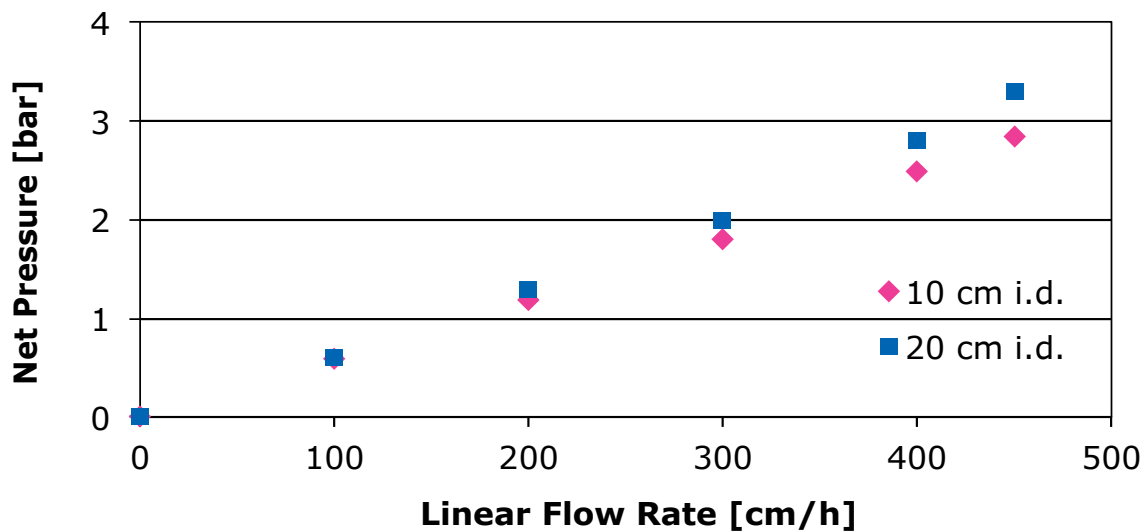

Figure 7.

Flow packed in 0.15 M NaCl, 20 cm bed height, 12% compression, running buffer: 0.15 M NaCl.

Easy Sanitization

Eshmuno® CP-FT resin is easily sanitized and has excellent stability under both alkaline and acidic conditions. Figure 8 demonstrates no significant differences in the separation of a three-protein mixture were observed after 100 clean-in-place (CIP) cycles (60-minutes exposure to 1.0 M sodium hydroxide per cycle).

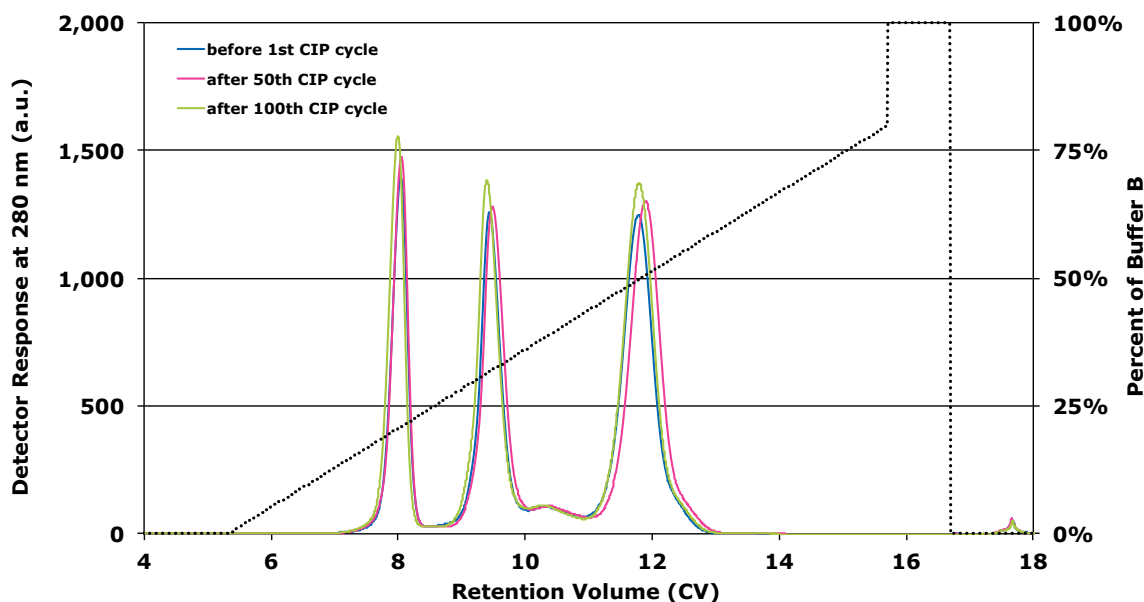

Figure 8.

A solution composed of β -lactoglobulin (7.0 mg/mL), cytochrome C (4.5 mg/mL) and lysozyme (3.5 mg/mL) in 50 mM sodium acetate at pH 5.0 was loaded onto a 7.85 mL (1.0 cm i.d., 10 cm bed height) column of Eshmuno® CP-FT resin. The proteins were slowly eluted off the column using a linear gradient of 50 mM sodium acetate at pH 5.0 and was increased to 80% of 1.0 M sodium chloride at pH 5.0 over 10 CV. The chromatograms shows the separation of β -lactoglobulin, cytochrome C and lysozyme on Eshmuno® CP-FT resin after run 1 (blue), run 50 (magenta), and run 100 (green) in which each run includes a 60 minute clean-in-place treatment with 1.0 M NaOH.

Process Development Tools

Eshmuno® CP-FT resin is available in pre-packed, ready-to-use columns. MiniChrom columns can be used for lab-scale process development with any standard chromatography system. RoboColumn® prepacked columns can be utilized for high-throughput process development in conjunction with a chromatography robot. These small-scale columns are the ideal tool for performing initial resin screening, scaling, and optimization studies.

Table 3.

Eshmuno® CP-FT Resin Characteristics

	Eshmuno® CP-FT Resin
Type of chromatography	Strong cation exchanger
Functional group	Sulfoisobutyl
Base material	Surface grafted rigid hydrophilic polyvinyl ether polymer
Mean particle size (d50)	50 μ m
pK value	<1
pH stability	pH 2 to 14
Mechanical stability	8 bar
Linear flow rate	up to 400 cm/h (< 3.0 bar net pressure) 20 x 10 cm i.d. column, 10-12% compression equivalent to 1.11-1.14 compression factor, 150 mM NaCl as mobile phase
Storage conditions	20% EtOH + 150 mM NaCl solution, ambient temperature
Shipping solution	20% EtOH v/v+ 150 mM NaCl solution

Ordering information

Description	Catalog Number
Eshmuno® CP-FT resin, 10 mL	1.20093.0010
Eshmuno® CP-FT resin, 100 mL	1.20093.0100
Eshmuno® CP-FT resin, 500 mL	1.20093.0500
Eshmuno® CP-FT resin, 5L	1.20093.5000
MiniChrom prepacked column with Column Eshmuno® CP-FT resin, 1mL 8x20mm	1.25168.0001
MiniChrom prepacked column with Column Eshmuno® CP-FT resin, 5mL 8x100mm	1.25169.0001
MiniChrom prepacked column with Column Eshmuno® CP-FT resin, 0.2mL 5x10mm	1.25170.0001
RoboColumn® prepacked column with Eshmuno® CP-FT resin, 0.2mL 8PC 5x10mm	1.25171.0001
RoboColumn® prepacked column with Eshmuno® CP-FT resin, 0.6mL 8PC 5x30mm	1.25172.0001
Buffer Preparation	
Phosphoric acid 75% EMPROVE® EXPERT	100250
di-Potassium hydrogen phosphate anhydrous EMPROVE® EXPERT Ph Eur,BP,USP	137010
Sodium chloride EMPROVE® EXPERT Ph Eur,BP,JP,USP	137017
Sodium dihydrogen phosphate dihydrate EMPROVE® EXPERT Ph Eur,BP,USP,JPE	137018
Sodium hydroxide pellets EMPROVE® EXPERT Ph Eur,BP,JP,NF	137020
Sodium hydroxide solution 1 mol/L EMPROVE® EXPERT	137031
Tris (hydroxymethyl)aminomethane (Trometamol) EMPROVE® ESSENTIAL Ph Eur,BP,JPC,USP	108386
Tris (hydroxymethyl)aminomethane (Trometamol) high purity EMPROVE® EXPERT Ph Eur,BP,JPC,USP,ACS	108307
Tris (hydroxymethyl)aminomethane hydrochloride EMPROVE® EXPERT	108219
Hydrochloric acid 1 mol/L EMPROVE® EXPERT	110165
Acetic acid 1 mol/L EMPROVE® EXPERT	137035
Acetic acid 30% EMPROVE® EXPERT Ph Helv	137047
Acetic acid (glacial) 100% EMPROVE® EXPERT Ph Eur,BP,JP,USP	137000
Sodium acetate anhydrous EMPROVE® EXPERT USP	137046
Sodium acetate trihydrate EMPROVE® EXPERT Ph Eur,BP,JP,USP	137012
Column Cleaning & Storage	
Ethanol 20% EMPROVE® EXPERT	480910
Ethanol 20 % (v/v) with 150 mMol/L sodium chloride solution EMPROVE® EXPERT	480940
Guanidinium chloride EMPROVE® EXPERT	137037
Sodium hydroxide solution 0,1 mol/L EMPROVE® EXPERT	137058
Sodium hydroxide solution 0,5 mol/L EMPROVE® EXPERT	137060
Ethanol absolute suitable for use as excipient EMPROVE® exp Ph Eur,BP,JP,USP	100986
2-Propanol 70 % (v/v) EMPROVE® EXPERT USP	137040
2-Propanol EMPROVE® ESSENTIAL Ph Eur,BP,JP,USP	100995
Benzyl alcohol EMPROVE® EXPERT Ph Eur,BP,JP,NF,ACS	137043

For additional information, please visit www.merckmillipore.com.

To place an order or receive technical assistance, please visit www.merckmillipore.com/contactPS

Merck KGaA
Frankfurter Strasse 250
64293 Darmstadt, Germany

